

UT - 56
TECHNICAL DATA

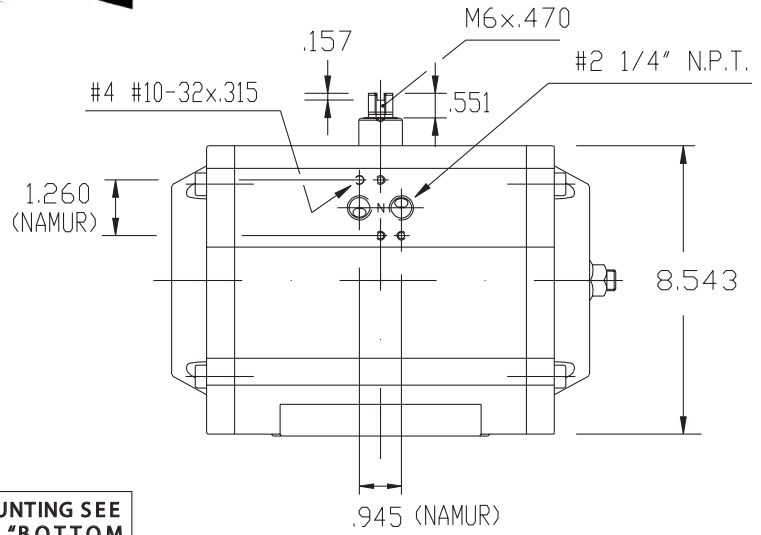

DIMENSIONS TO
ISO 5211 - DIN 3337
AND NAMUR VDI/DE 3845
DIMENSIONS IN INCHES

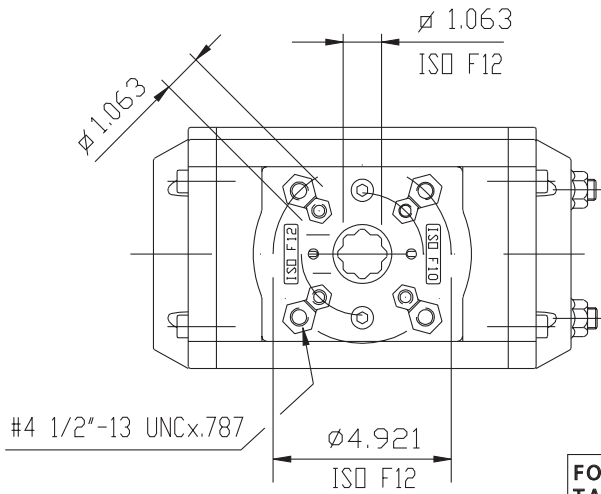

FOR MOUNTING SEE
TABLE "BOTTOM
MOUNTING PLATE
DIMENSIONS"

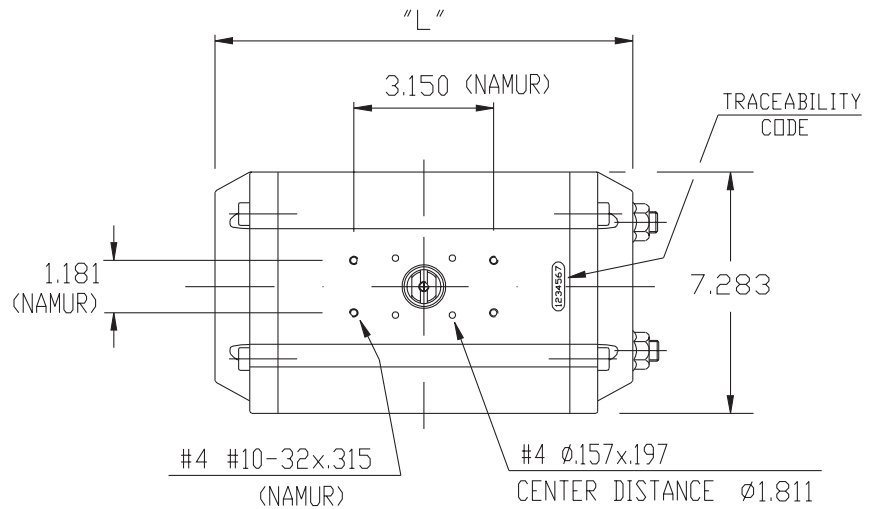
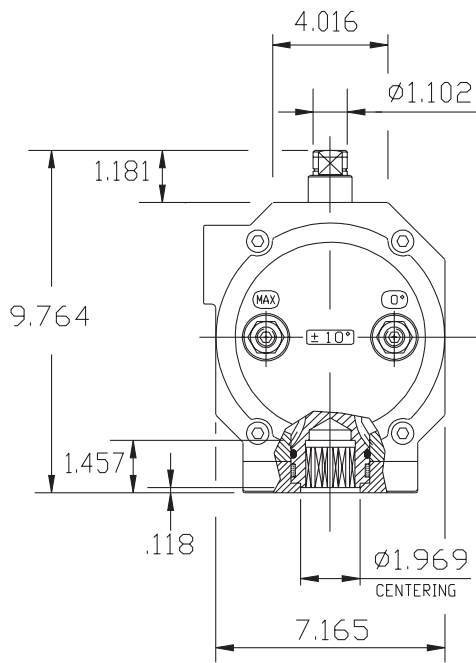

	90°	120°	135°	150°	180°
"L"	16.457	18.937	20.197	21.417	23.898

WEIGHT

STROKE	DOUBLE ACTING					SPRING RETURN 7+5 SPRING
	90°	120°	135°	150°	180°	90°
LB.	48.90	54.56	57.43	60.29	65.81	59.53

AIR CONSUMPTION (FULL CYCLE)

STROKE	DOUBLE ACTING					SPRING RETURN 7+5 SPRING
	90°	120°	135°	150°	180°	90°
CU.-IN.	565.5	681.3	737.5	793.8	906.3	256.3