

UT-31
TECHNICAL DATA

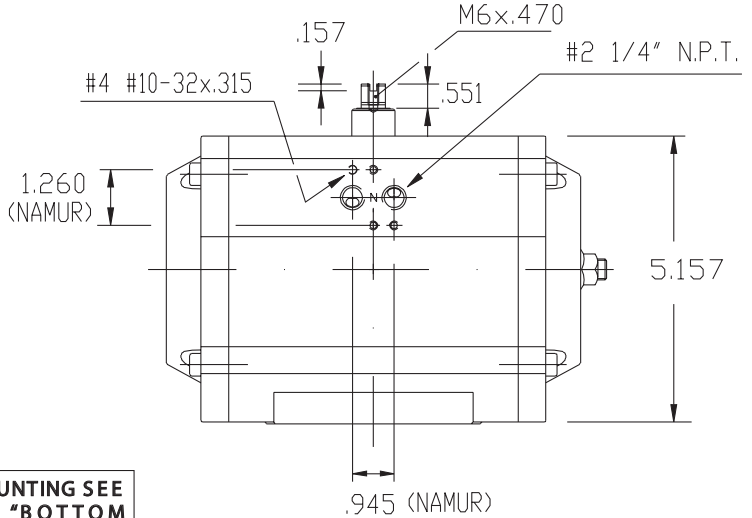

DIMENSIONS TO
ISO 5211 - DIN 3337
AND NAMUR VDI/DE 3845
DIMENSIONS IN INCHES

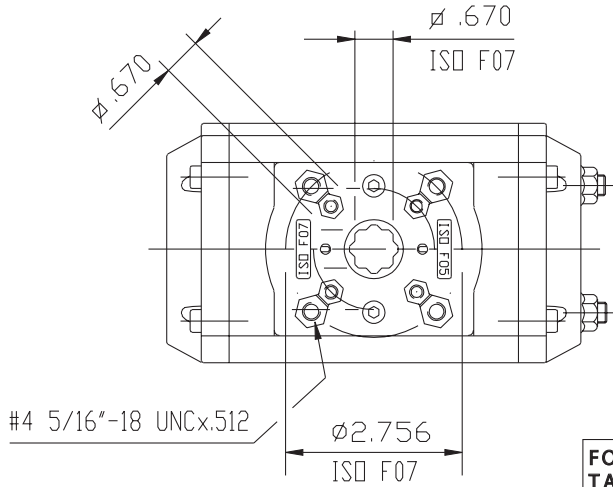

FOR MOUNTING SEE
TABLE "BOTTOM
MOUNTING PLATE
DIMENSIONS"

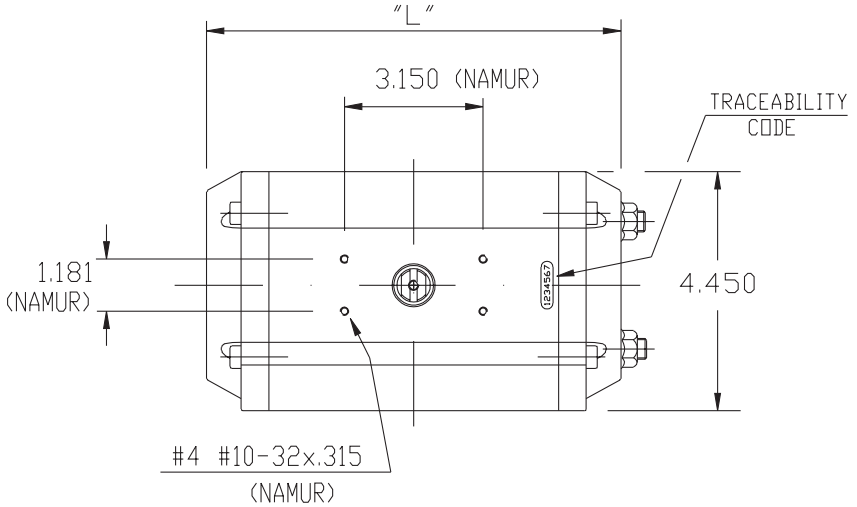
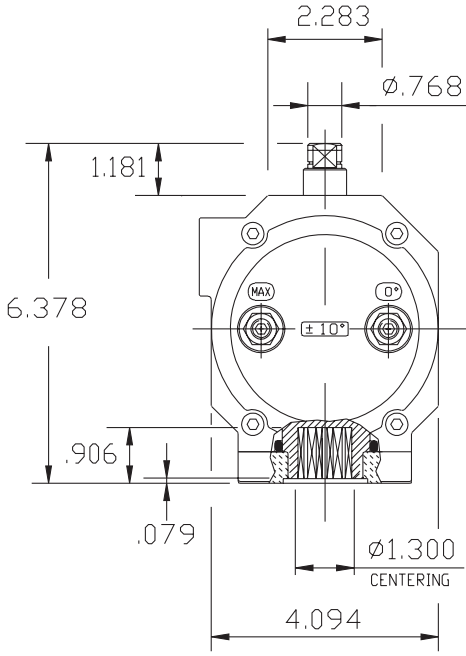

	90°	120°	135°	150°	180°
"L"	9.055	10.709	11.024	11.850	13.031

WEIGHT

STROKE	DOUBLE ACTING					SPRING RETURN 7+5 SPRING
	90°	120°	135°	150°	180°	90°
LB.	10.67	12.61	12.85	13.56	14.88	12.28

AIR CONSUMPTION (FULL CYCLE)

STROKE	DOUBLE ACTING					SPRING RETURN 7+5 SPRING
	90°	120°	135°	150°	180°	90°
CU.-IN.	88.9	115.6	118.8	129.4	150.0	40.6