

UT-26
TECHNICAL DATA

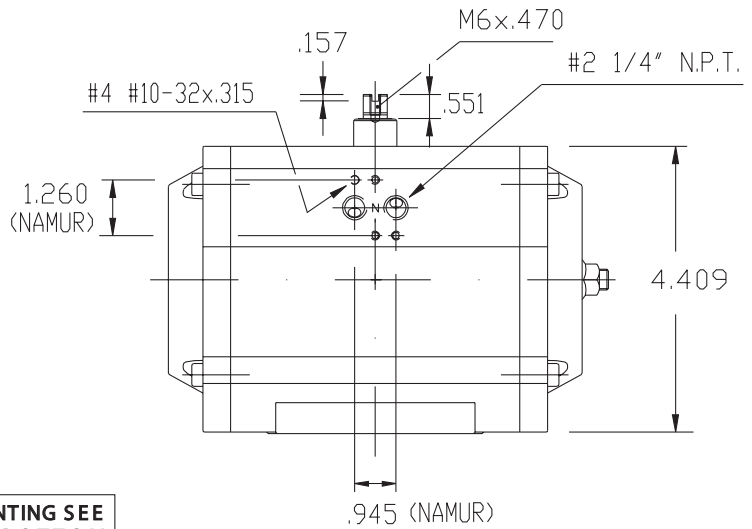

DIMENSIONS TO
ISO 5211 - DIN 3337
AND NAMUR VDI/DE 3845
DIMENSIONS IN INCHES

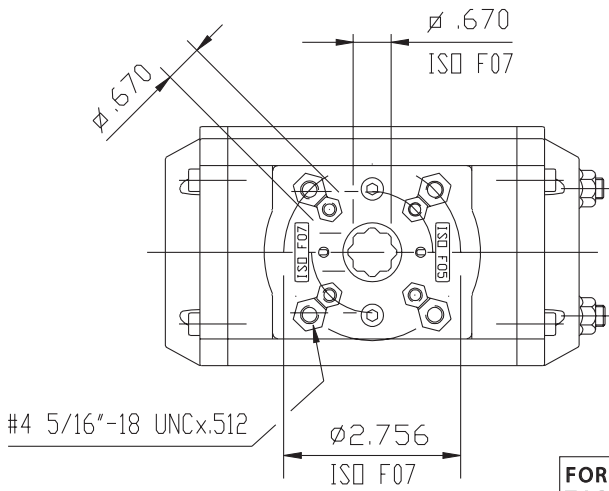

FOR MOUNTING SEE
TABLE "BOTTOM
MOUNTING PLATE
DIMENSIONS"

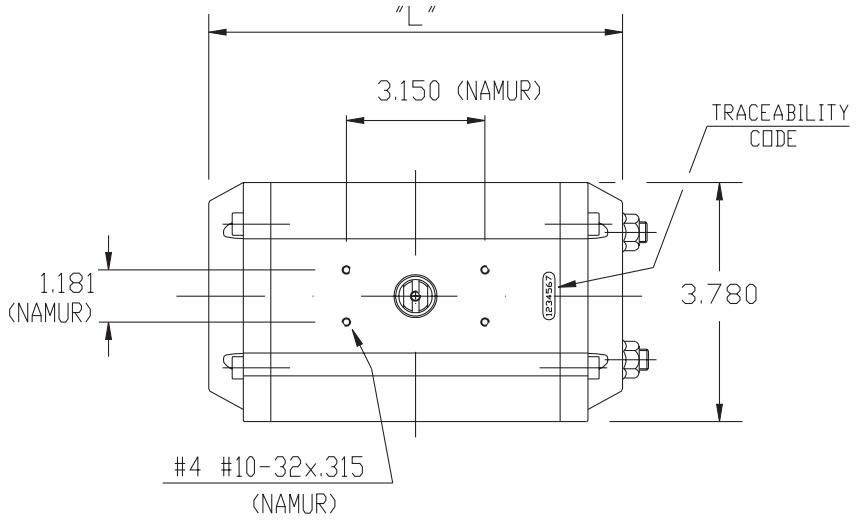
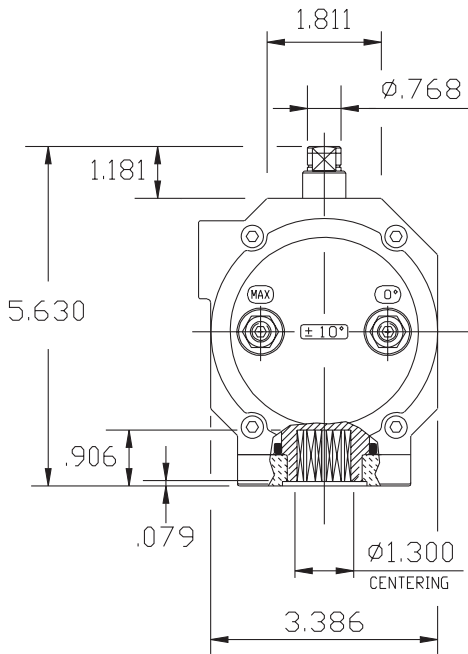

	90°	120°	135°	150°	180°
"L"	9.409	11.024	11.024	11.850	12.992

WEIGHT

STROKE	DOUBLE ACTING					SPRING RETURN 7+5 SPRING
	90°	120°	135°	150°	180°	90°
LB.	8.82	10.14	10.25	10.91	11.79	9.88

AIR CONSUMPTION (FULL CYCLE)

STROKE	DOUBLE ACTING					SPRING RETURN 7+5 SPRING
	90°	120°	135°	150°	180°	90°
CU.-IN.	68.7	90.6	93.7	103.1	118.7	30.0